

## RSL15

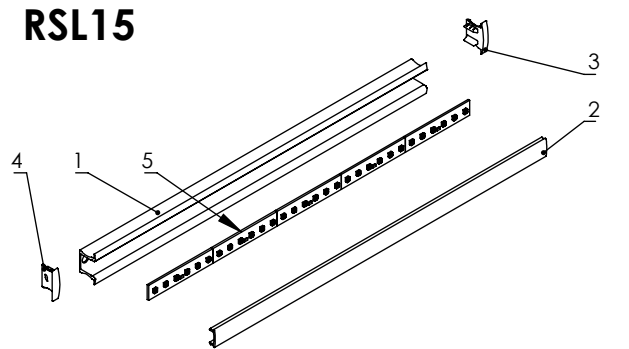

Nr	Code	Comments	Quantity
1	AL-RSL15	1, 2 or 3[m]	1
2	AB-SL-K/M/50M/L30K/M/L60K/M	diffuser 1 or 2 or 3[m]	1
3	EC-RSL15-H3	aluminium end cap w/out cable hole	1
4	EC-RSL15-H4	aluminium end cap with cable hole (or made cable hole pos.1)	1
5	12x300 PCB with 3528 LEDS	strips of LED	

**1**

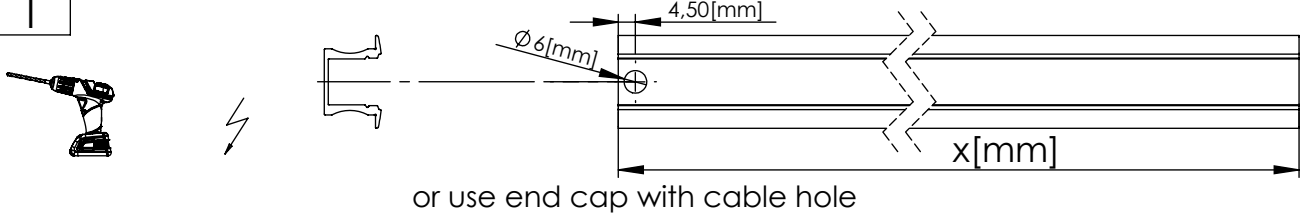

or use end cap with cable hole

**2**

Use thermally conductive tape

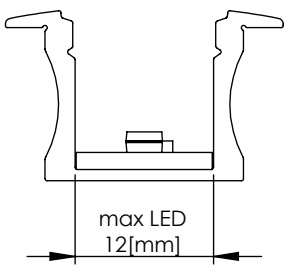

max LED  
12[mm]

**3**

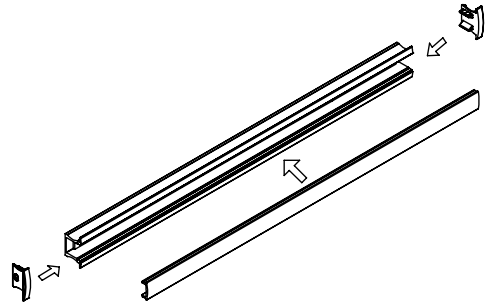

**4**

cutting hole

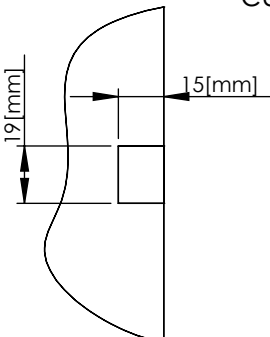

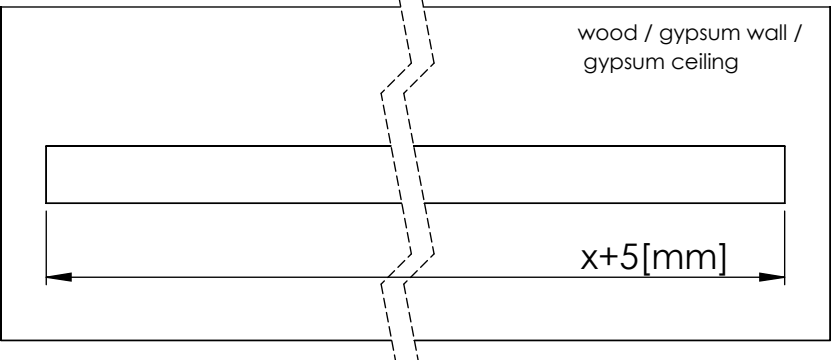

wood / gypsum wall /  
gypsum ceiling

$x+5[mm]$

**5**

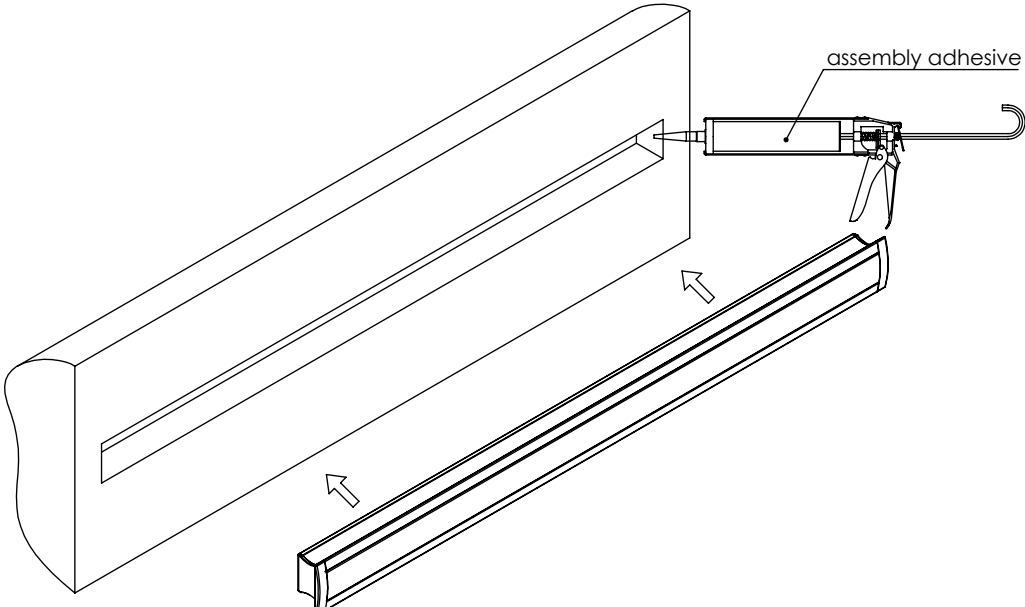

assembly adhesive