

SKYE 3 40 W

ASCENT

3 x 39,8 W | IRC 90+

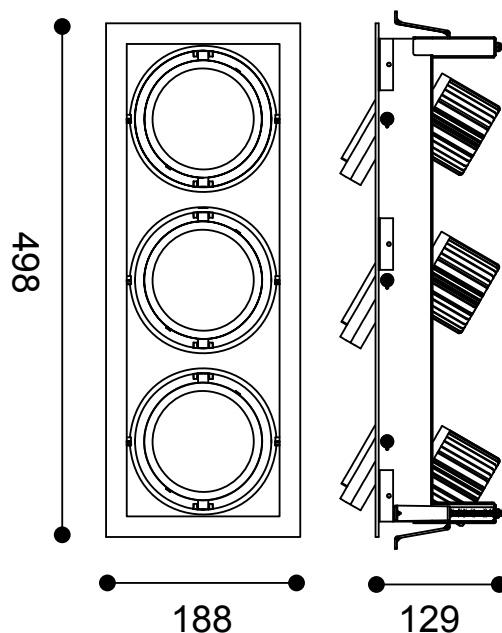

Type	Downlight
Tension	37,1 V
Courant	1 050 mA
Puissance	3 x 39,8 W
Flux	3 x 3 888 lm - 3000 K - IRC 90+
Angles	12°, 24°, 40°
UGR	<19
Classe	III
Protection	IP20
Encastrement	475 x 175 mm
Hauteur	129 mm
Dimensions	498 x 188 mm
Inclinaisons	0 - 30° 360°
Matériau	Aluminium
Finition	Blanc / Noir
Durée de vie	60 000 H L70

Référence	K	Angles	Flux lumineux / IRC
SK3401227*		12°	
SK3402427*	2 700 K	24°	3 x 3 721 lm / IRC 90+
SK3404027*		40°	
SK3401230*		12°	
SK3402430*	3 000 K	24°	3 x 3 888 lm / IRC 90+
SK3404030*		40°	
SK3401240*		12°	
SK3402440*	4 000 K	24°	3 x 4 006 lm / IRC 90+
SK3404040*		40°	

* : B : Blanc / N : Noir

Autres colorimétries sur demande.

Alimentations (à commander séparément) :

- ✓ Mean Well LPC60-1050, non gradable
- ✓ Gradation 1-10 V | DALI | TRIAC : nous consulter

