

SKYE 3 25W

ASCENT

3 x 25,9 W | IRC 90+

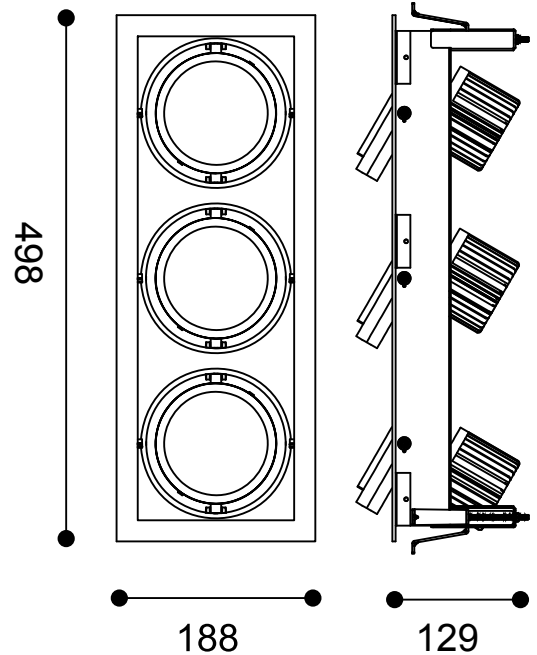

Type	Downlight
Tension	37,1 V
Courant	700 mA
Puissance	3 x 25,9 W
Flux	3 x 2 559 lm - 3000 K - IRC 90+
Angles	12°, 24°, 40°
UGR	<19
Classe	III
Protection	IP20
Encastrement	475 x 175 mm
Hauteur	129 mm
Dimensions	498 x 188 mm
Inclinaisons	0 - 30° 360°
Matériau	Aluminium
Finition	Blanc / Noir
Durée de vie	60 000 H L70

Référence	K	Angles	Flux lumineux / IRC
SK3251227*		12°	
SK3252427*	2 700 K	24°	3 x 2 447 lm / IRC 90+
SK3254027*		40°	
SK3251230*		12°	
SK3252430*	3 000 K	24°	3 x 2 559 lm / IRC 90+
SK3254030*		40°	
SK3251240*		12°	
SK3252440*	4 000 K	24°	3 x 2 636 lm / IRC 90+
SK3254040*		40°	

* : B : Blanc / N : Noir

Autres colorimétries sur demande.

Alimentations (à commander séparément) :

- ✓ Mean Well APC35-700, non gradable
- ✓ Gradation 1-10 V | DALI | TRIAC : nous consulter

